

# Owners Manual

## Table Soccer

Model#SUO-4824P-6

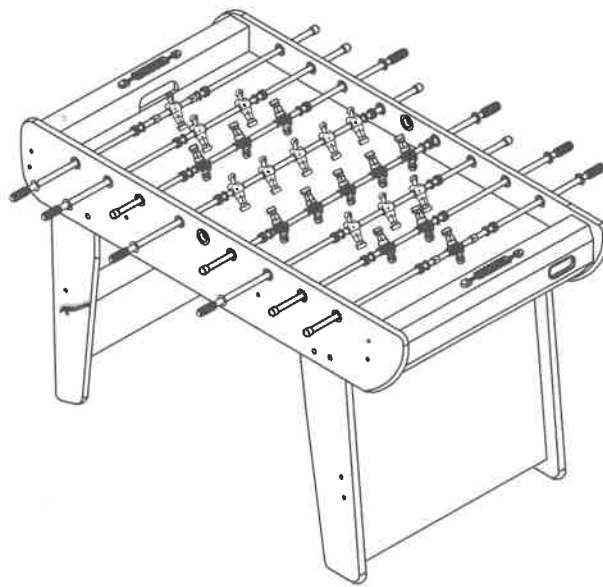

.Assembly Instructions

.Parts List











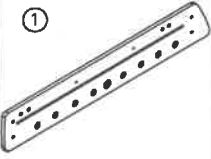
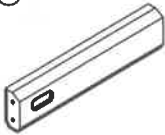
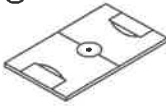

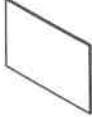













**WARNING: Choking Hazard--Toy contains small balls and/or small parts. Not for children under 3 years.**

## IMPORTANT!

**Please Keep Your Instructions.** Before attempting assembly, please read through this instruction book to familiarize yourself with all the parts and assembly steps. We recommend that two adults assemble this game. Please refer to the Parts List below and be sure that all parts have been included.

## PARTS LIST

①  SIDE APRON 2EA	②  END APRON 2EA	③  SOCCER PLAYFIELD 1EA	④  END LEG BRACE 2EA	⑤  END LEG BRACE 2EA	⑥  SUPPORT BRACE 2EA
⑦  LEFT LEG 2EA	⑧  RIGHT LEG 2EA	⑨  6X30MM LEG BOLT 16EA	⑩  18X6.5MM WASHER 24EA	⑪  6X50MM LEG BOLT 8EA	⑫  3.5X35MM WASHER HEAD SCREW 4EA
⑬  3.5X21MM FLAT HEAD SCREW 4EA	⑭  1 PLAYER ROD/3 PLAYER ROD 4EA	⑮  2 PLAYER ROD 2EA	⑯  5 PLAYER ROD 2EA	⑰  STOP RING 4 EA	⑱  RUBBER BUMPER 16 EA
⑲  PLAYER (RED) 11 EA	⑳  PLAYER (BLUE) 11 EA	㉑  3.5X7MM ROUND HEAD SCREW 52 EA	㉒  SCORER 2EA	㉓  BLACK HAND GRIP 8EA	㉔  END CAP 8EA
㉕  SOCCER BALL 2EA	㉖  ALLEN WRENCH 1EA				

### ASSEMBLY INSTRUCTIONS:

We recommend that two adults work together to assemble this game.

- 1) Open the carton of your new table game near where you will play. Select a clear level floor. This game requires at least two adults to assemble the table.
- 2) Remove all the contents from inside the carton and verify that you have all listed parts as shown on the Parts List.  
NOTE: We suggest that you use the bottom carton as a clean flat working area to protect the game. Carefully cut or tear the four carton corners so that the bottom is now your work area.

**FIG.1.**

- 3) Attach one End Apron (#2) between the Side Aprons (#1) using two of Bolts (#9) and three of Washers (#10) per Side. See FIG.1.  
NOTE: Leave connections loose - Do not tighten screws securely at this time.
- 4) Slide the Playfield (#3) with graphics facing down as shown in FIG.1. If the field does not slide smoothly, check to be sure you have not over tightened any screws or the playfield is not caught by the slot.

**FIG.2.**

- 5) Repeat the step to attach the other End Apron (#2) to Side Aprons (#1). Center the playfield between the two end aprons, and make sure that the playfield is in the grooves of side aprons and end aprons. NOTE: Be sure that two side aprons and end aprons are square. Now go back and tighten all the connections.
- 6) Place two Support Braces (#6) on Playfield (#3) as shown in FIG.3. Attach them using two of Washer Head Screws (#12) per Side. See FIG.2.

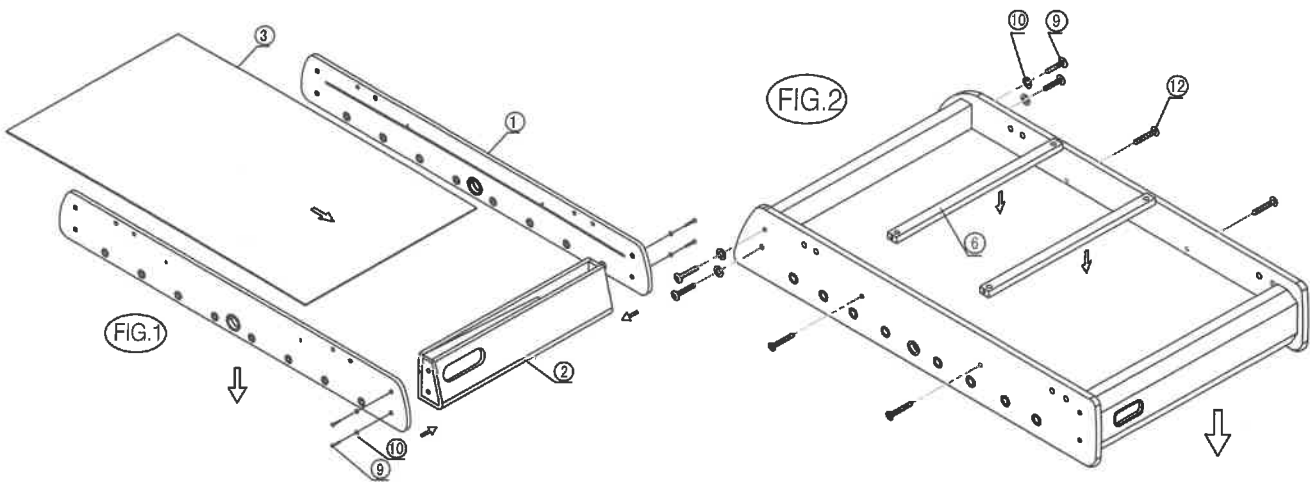

**FIG.3.**

- 7) Attach the Left (#7) and Right (#8) Legs to the cabinet using two of Leg Bolts (#9) and two of Washers (#10) per Leg. See FIG.3.
- 8) Place the End Leg Braces (#5) in the groove of Legs. See FIG.3.

**FIG.4.**

- 11) Attach the two End Leg Braces (#4) to the Legs using two of Bolts (#11) and two of Washers (#10) per Leg. See FIG.4.
- 12) Lift the table assembly from the floor with two strong adults, turn it over, and set table on its legs in the location where you will play. Go back and make sure that all connections are tight.

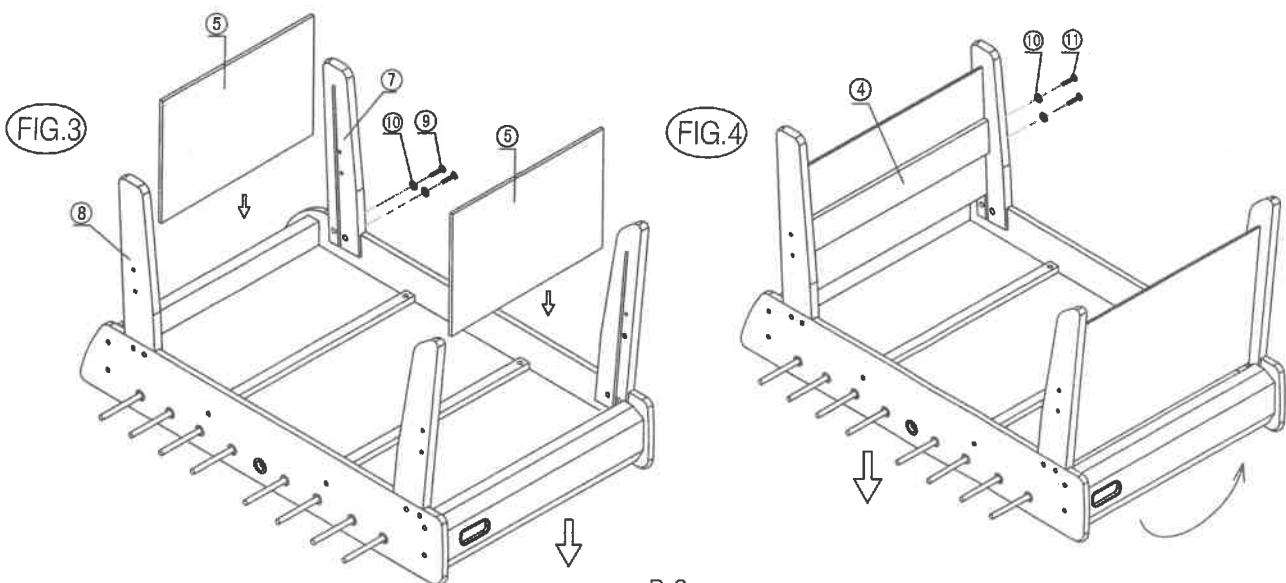

FIG.5.

7) Attach the player rods (#14 - #16) into the side aprons as shown in Fig.5-1. Attach rubber bumper (#18) to the player rod, followed by the players (#19 & #20) and another rubber bumper (#18). For the two goalie player rods an additional stop ring (#17) will be needed to be added between the goalie.

8) Attach Stop Rings (#17) and Players (#19 & #20) to the player rods using Round Head Screws (#21) as shown in Fig.5-2.

FIG.5

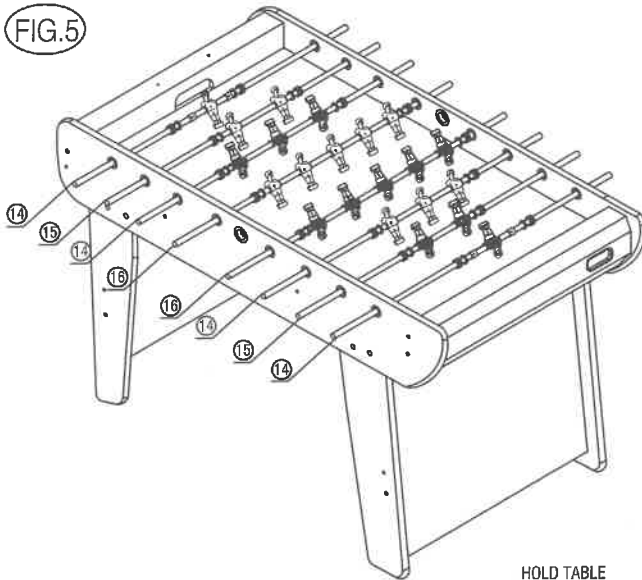

FIG.5-1

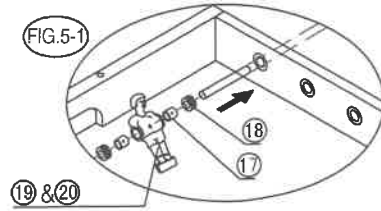
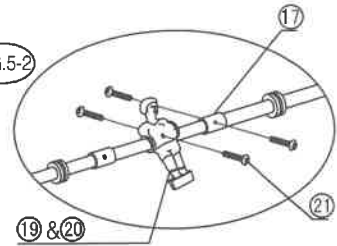

FIG.5-2



**CAUTION:** Two strong adults are recommended to flip the table as shown.  
1. Grab the table on the ground.  
2. Turn the table over.  
3. Place it on all four feet at the same time on the ground.

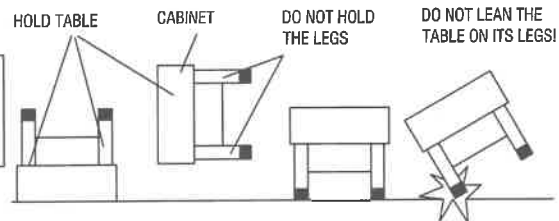

FIG.6.

13) Put the Black (#23) Hand Grips and the End Caps (#24) on the player rods in order. The Hand Grips go on the ends of the rods with holes in them. NOTE: To make the Handles easier to attach, spray a little window cleaner on the rod ends prior to installation and tap on gently with a hammer. See FIG.6.

14) Attach the two Scorers (#22) to the Top Slat Board using two of Flat Head Screws (#13) per Scorer. See FIG.6.

FIG.6

